

5400 Series

Low Air Inclusion Refrigerant



The 5400 Series low air inclusion product line is designed for air conditioning, refrigerant, gaseous and fluid transfer applications.

Product Features

- Brazed or threaded end connections for versatility of installation on tubing or hose
- Tubular valve construction for low fluid loss and air inclusion
- Thread together design allows connection and disconnection against pressure
- Lock washer and jam nut standard for optional bulkhead mounting
- Standard seal material – Neoprene
- Standard adapter material – Steel or Brass
- Standard body material – High resistance carbon steel with zinc trivalent plating

Physical Characteristics

Coupling Size	Max. Operating Pressure Connected		Min. Burst Pressure Connected		Max. Operating Pressure Disconnected				Vacuum Connected Only		Rated Flow	Air Inclusion	Fluid Loss
	bar	(psi)	bar	(psi)	bar	(psi)	bar	(psi)	(in./Hg)	L/min	(gpm)	cc. max.	cc.max.
-4	207	(3,000)	621	(9,000)	172	(2,500)	34	(500)	28	8	(2)	.10	.05
-8	121	(1,750)	359	(5,200)	121	(1,750)	28	(400)	28	53	(14)	.10	.10
-12	48	(700)	145	(2,100)	55	(800)	28	(400)	28	132	(35)	.30	.10
-16	48	(700)	145	(2,100)	48	(700)	21	(300)	28	284	(75)	.50	.20

REFRIGERANT



Applications

- Mobile air conditioning and refrigerant



Flow Data

Pressure Drop Versus Flow Graph

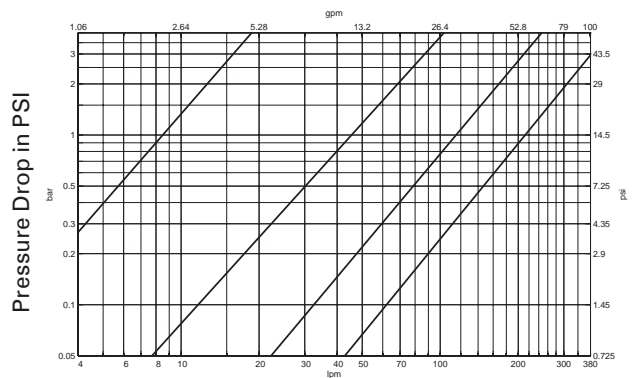

Cubic Feet Per Minute Flow
Test Fluid: Air at 100 PSI Inlet Pressure

5400 Series

Low Air Inclusion Refrigerant

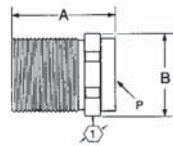

Figure 1

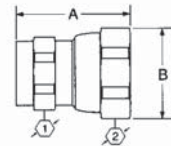

Figure 2

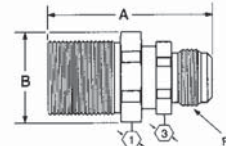

Figure 3

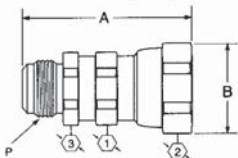

Figure 4

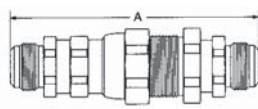

Figure 5

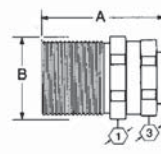

Figure 6

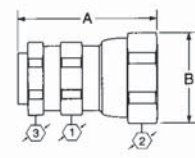

Figure 7

Dimensions – No Adapter

Part Number Neoprene	Coupling Type	Body Size	Type	Fig.	Dimensions		Hex ①		Hex ②		Hex ③			
					A	B	mm	(in)	mm	(in)	mm	(in)	mm	(in)
5400-S2-4	Male	1/4	No Adapter	1	27.4	(1.08)	21.1	(.83)	19.1	(.75)	-	-	-	-
5400-S5-4	Female	1/4	No Adapter	2	33.3	(1.31)	21.1	(.83)	16.0	(.63)	19.1	(.75)	-	-
5400-S2-8	Male	1/2	No Adapter	1	34.8	(1.37)	31.8	(1.25)	33.3	(1.31)	-	-	-	-
5400-S5-8	Female	1/2	No Adapter	2	41.4	(1.63)	33.3	(1.31)	25.4	(1.00)	30.2	(1.19)	-	-
5400-S2-12	Male	3/4	No Adapter	1	44.2	(1.74)	46.5	(1.83)	41.4	(1.63)	-	-	-	-
5400-S5-12	Female	3/4	No Adapter	2	54.6	(2.15)	45.7	(1.80)	35.1	(1.38)	41.4	(1.63)	-	-
5400-S2-16	Male	1	No Adapter	1	46.5	(1.83)	53.3	(2.10)	47.8	(1.88)	-	-	-	-
5400-S5-16	Female	1	No Adapter	2	60.2	(2.37)	56.9	(2.24)	44.5	(1.75)	50.8	(2.00)	-	-

Dimensions – SAE 37° (JIC)

Part Number Buna-N	Coupling Type	Body Size	Port Size	Thread	Type	Fig.	Dimensions		Hex ①		Hex ②		Hex ③	
							A	B	mm	(in)	mm	(in)	mm	(in)
5410-S17-4-4*	Male	1/4	7/16	7/16-20	SAE 37° (JIC)	3	47.8	(1.88)	21.1	(.83)	19.1	(.75)	-	16.0 (.63)
5410-S14-4-4*	Female	1/4	7/16	7/16-20	SAE 37° (JIC)	4	49.0	(1.93)	21.1	(.83)	16.0	(.63)	19.1 (.75)	15.7 (.62)
5410-4-4*	Complete	1/4	7/16	7/16-20	SAE 37° (JIC)	5	89.9	(3.54)	-	-	-	-	-	-
5410-S17-6-4*	Male	1/4	9/16	9/16-18	SAE 37° (JIC)	3	48.0	(1.89)	21.1	(.83)	19.1	(.75)	-	16.0 (.63)
5410-S14-6-4*	Female	1/4	9/16	9/16-18	SAE 37° (JIC)	4	49.3	(1.94)	21.1	(.83)	16.0	(.63)	19.1 (.75)	15.7 (.62)
5410-6-4*	Complete	1/4	9/16	9/16-18	SAE 37° (JIC)	5	90.4	(3.56)	-	-	-	-	-	-
5410-S17-6-8*	Male	1/2	9/16	9/16-18	SAE 37° (JIC)	3	55.4	(2.18)	31.8	(1.25)	28.7	(1.13)	-	25.4 (1.00)
5410-S14-6-8*	Female	1/2	9/16	9/16-18	SAE 37° (JIC)	4	61.7	(2.43)	33.3	(1.31)	25.4	(1.00)	30.2 (1.19)	25.4 (1.00)
5410-6-8*	Complete	1/2	9/16	9/16-18	SAE 37° (JIC)	5	107.4	(4.23)	-	-	-	-	-	-
5410-S17-8-8*	Male	1/2	3/4	3/4-16	SAE 37° (JIC)	3	57.9	(2.28)	31.8	(1.25)	28.7	(1.13)	-	25.4 (1.00)
5410-S14-8-8*	Female	1/2	3/4	3/4-16	SAE 37° (JIC)	4	64.3	(2.53)	33.3	(1.31)	25.4	(1.00)	30.2 (1.19)	25.4 (1.00)
5410-8-8*	Complete	1/2	3/4	3/4-16	SAE 37° (JIC)	5	112.8	(4.44)	-	-	-	-	-	-
5410-S17-10-12*	Male	3/4	7/8	7/8-14	SAE 37° (JIC)	3	69.9	(2.75)	46.5	(1.83)	41.4	(1.63)	-	35.1 (1.38)
5410-S14-10-12*	Female	3/4	7/8	7/8-14	SAE 37° (JIC)	4	80.3	(3.16)	45.7	(1.80)	35.1	(1.38)	41.1 (1.62)	35.1 (1.38)
5410-10-12*	Complete	3/4	7/8	7/8-14	SAE 37° (JIC)	5	135.4	(5.33)	-	-	-	-	-	-
5410-S17-12-12*	Male	3/4	1 1/16	1 1/16-12	SAE 37° (JIC)	3	72.6	(2.86)	46.5	(1.83)	41.4	(1.63)	-	35.1 (1.38)
5410-S14-12-12*	Female	3/4	1 1/16	1 1/16-12	SAE 37° (JIC)	4	83.1	(3.27)	45.7	(1.80)	35.1	(1.38)	41.1 (1.62)	35.1 (1.38)
5410-12-12*	Complete	3/4	1 1/16	1 1/16-12	SAE 37° (JIC)	5	140.7	(5.54)	-	-	-	-	-	-
5410-S17-16-16*	Male	1	5/16	5/16-12	SAE 37° (JIC)	3	75.9	(2.99)	53.3	(2.10)	47.8	(1.88)	-	44.5 (1.75)
5410-S14-16-16*	Female	1	5/16	5/16-12	SAE 37° (JIC)	4	89.7	(3.53)	56.9	(2.24)	44.5	(1.75)	50.8 (2.00)	44.5 (1.75)
5410-16-16*	Complete	1	5/16	5/16-12	SAE 37° (JIC)	5	149.6	(5.89)	-	-	-	-	-	-

*Couplings must be ordered by components as shown on page 65.

5400 Series

Low Air Inclusion Refrigerant

Dimensions – Braze Tubing Adapter

Part Number Neoprene	Coupling Type	Body Size	Tube O.D. Size	Type	Fig.	Dimensions									
						A		B		Hex ①		Hex ②		Hex ③	
						mm	(in)	mm	(in)	mm	(in)	mm	(in)	mm	(in)
5401-S17-4-4*	Male	1/4	1/4	Braze Tubing Adapter	6	38.6	(1.52)	21.1	(.83)	19.1	(.75)	-	-	16.0	(.63)
5401-S14-4-4*	Female	1/4	1/4	Braze Tubing Adapter	7	39.9	(1.57)	21.1	(.83)	16.0	(.63)	19.1	(.75)	16.0	(.63)
5401-S17-6-4*	Male	1/4	3/8	Braze Tubing Adapter	6	38.6	(1.52)	21.1	(.83)	19.1	(.75)	-	-	16.0	(.63)
5401-S14-6-4*	Female	1/4	3/8	Braze Tubing Adapter	7	39.9	(1.57)	21.1	(.83)	16.0	(.63)	19.1	(.75)	16.0	(.63)
5410-S17-6-8*	Male	1/2	3/8	Braze Tubing Adapter	6	44.5	(1.75)	33.3	(1.31)	28.7	(1.13)	-	-	25.4	(1.00)
5401-S14-6-8*	Female	1/2	3/8	Braze Tubing Adapter	7	50.8	(2.00)	33.3	(1.31)	25.4	(1.00)	30.2	(1.19)	25.4	(1.00)
5401-S17-8-8*	Male	1/2	1/2	Braze Tubing Adapter	6	44.5	(1.75)	33.3	(1.31)	28.7	(1.13)	-	-	25.4	(1.00)
5401-S14-8-8*	Female	1/2	1/2	Braze Tubing Adapter	7	50.8	(2.00)	33.3	(1.31)	25.4	(1.00)	30.2	(1.19)	25.4	(1.00)
5401-S17-10-12*	Male	3/4	5/8	Braze Tubing Adapter	6	62.7	(2.47)	45.7	(1.80)	41.4	(1.63)	-	-	35.1	(1.38)
5401-S14-10-12*	Female	3/4	5/8	Braze Tubing Adapter	7	73.2	(2.88)	45.7	(1.80)	35.1	(1.38)	41.4	(1.63)	35.1	(1.38)
5401-S17-12-12*	Male	3/4	3/4	Braze Tubing Adapter	6	62.7	(2.47)	45.7	(1.80)	41.4	(1.63)	-	-	35.1	(1.38)
5401-S14-12-12*	Female	3/4	3/4	Braze Tubing Adapter	7	73.2	(2.88)	45.7	(1.80)	35.1	(1.38)	41.4	(1.63)	35.1	(1.38)
5401-S17-16-16*	Male	1	1	Braze Tubing Adapter	6	71.1	(2.80)	56.9	(2.24)	47.8	(1.88)	-	-	44.5	(1.75)
5401-S14-16-16*	Female	1	1	Braze Tubing Adapter	7	84.8	(3.34)	56.9	(2.24)	44.5	(1.75)	50.8	(2.00)	44.5	(1.75)

*Couplings must be ordered by components as shown on page 65.

Dust Caps and Dust Plugs

Dust Cap with Gasket	Dust Plug with Gasket	Body Size
5400-S6-4	5400-S8-4	1/4
5400-S6-8	5400-S8-8	-1/2
5400-S6-12	5400-S8-12	3/4
5400-S6-16	5400-S8-16	1

Dust Cap Dust Plug



Adapter SAE 37° (JIC)

O-ring	Brass	Steel	Body Size	Thread	Tube O.D. Size
22546-12	202220-4-4B	202220-4-4S	1/4	7/16-20	1/4
22546-12	202220-6-4B	202220-6-4S	1/4	9/16-18	3/8
22546-17	202220-6-8B	202220-6-8S	1/2	9/16-18	3/8
22546-17	202220-8-8B	202220-8-8S	1/2	3/4-16	1/2
22546-23	202220-10-12B	202220-10-12S	3/4	7/8-14	5/8
22546-23	202220-12-12B	202220-12-12S	3/4	1 1/16-12	3/4
22546-28	202220-16-16B	202220-16-16S	1	1 3/16-12	1

Adapter SAE 37° (JIC)

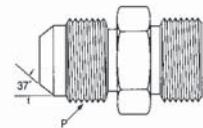

Adapter – Braze

O-ring	Brass	Steel	Body Size	Thread	Tube O.D. Size
22546-12	202208-4-4B	-	1/4	1/2-20	1/4
22546-17	202208-4-8B	-	1/2	7/8-20	1/2
22546-12	202208-6-4B	-	1/4	1/2-20	3/8
22546-17	202208-6-8B	-	1/2	7/8-20	3/8
22546-17	202208-8-8B	-	1/2	7/8-20	1/2
22546-17	202208-10-8B	-	1/2	7/8-20	5/8
22546-23	202208-10-12B	-	3/4	1 1/4-18	5/8
22546-23	202208-12-12B	-	3/4	1 1/4-18	3/4
22546-23	202202-14-12B	-	1	1 1/4-18	7/8
22546-28	202208-14-16B	-	1	1 19/32-20	7/8
22546-28	202208-16-16B	-	1	1 19/32-20	1
22546-28	202208-18-16B	-	1	1 19/32-20	1 1/8
22546-28	202208-22-16B	-	1	1 19/32-20	1 1/4

Adapter – Braze
(O-ring Required)



Hose Fitting SAE 100R5†

O-ring	Fitting Assembly	Body Size	Hose Size	Thread	Dimensions D	
					mm	(in)
22546-12	487-4-4S	1/4	-4	1/2-20	23.4	(.92)
22546-12	487-4-6S	1/4	-6	1/2-20	24.4	(.96)
22546-17	487-8-6S	1/2	-6	7/8-20	24.4	(.96)
22546-17	487-8-8S	1/2	-8	7/8-20	26.9	(1.06)
22546-23	487-12-10S	3/4	-10	1 1/4-18	27.2	(1.07)
22546-28	487-16-16S	1	-16	1 19/32-20	25.7	(1.01)

Hose Fitting SAE 100R5
(O-ring Required)

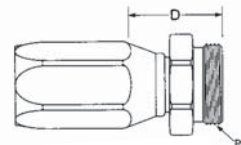

†Additional dash styles available.

5400 Series

Low Air Inclusion Refrigerant

For assemblies, order by components as shown by base number and dash (-) size below. Example, if a 5401-S14-10-12 is required, order as components, (1) 5400-S5-12, (1) 202208-10-12B Adapter and (1) 22546-23 O-ring.

Assembly Part Number	5400-S2 Female Half	Quantity	5400-S5 Male Half	Quantity	202208-Brass Braze-On Adapter	Quantity	202220-Steel 37" SAE Adapter	Quantity	22546 O-ring	Quantity
5401-S14-10-12			-12	1	-10 -12B	1			-23	1
5401-S14-10-8			-8	1	-10 -8B				-17	1
5401-S14-12-12			-12	1	-12 -12B	1			-23	1
5401-S14-16-16			-16	1	-16 -16B	1			-28	1
5401-S14-4-4			-4	1	-4 -4B	1			-12	1
5401-S14-6-4			-4	1	-6 -4B	1			-12	1
5401-S14-6-8			-8	1	-6 -8B	1			-17	1
5401-S14-8-8			-8	1	-8 -8B	1			-17	1
5401-S17-10-12	-12	1			-10 -12B	1			-23	1
5401-S17-10-8	-8	1			-10 -8B	1			-17	1
5401-S17-12-12	-12	1			-12 -12	1			-23	1
5401-S17-14-16	-16	1			-16 -16	1			-28	1
5401-S17-4-4	-4	1			-4 -4B	1			-17	1
5401-S17-6-4	-4	1			-6 -4B	1			-12	1
5401-S17-6-8	-8	1			-6 -8B	1			-17	1
5401-S17-8-8	-8	1			-8 -8B	1			-17	1
5410-12-12	-12	1	-12	1			-12 -12S	2	-23	2
5410-16-16	-16	1	-16	1			-16 -16S	2	-28	2
5410-4-4	-4	1	-4	1			-4 -4S	2	-12	2
5410-6-8	-8	1	-8	1			-6 -8S	2	-17	2
5410-8-8	-8	1	-8	1			-8 -8S	2	-17	2
5410-S14-10-12			-12	1			-10 -12S	1	-23	1
5410-S14-12-12			-12	1			-12 -12S	1	-23	1
5410-S14-16-16			-16	1			-16 -16S	1	-28	1
5410-S14-4-4			-4	1			-4 -4S	1	-12	1
5410-S14-6-4			-4	1			-6 -4S	1	-12	1
5410-S14-6-8			-8	1			-6 -8S	1	-17	1
5410-S14-8-8			-8	1			-8 -8S	1	-17	1
5410-S17-10-12	-12	1					-10 -12S	1	-23	1
5410-S17-12-12	-12	1					-12 -12S	1	-23	1
5410-S17-16-16	-16	1					-16 -16S	1	-28	1
5410-S17-4-4	-4	1					-4 -4S	1	-12	1
5410-S17-6-4	-4	1					-6 -4S	1	-12	1
5410-S17-6-8	-8	1					-6 -8S	1	-17	1
5410-S17-8-8	-8	1					-8 -8S	1	-17	1

5400 Series

Low Air Inclusion Refrigerant

Assembly Instructions/Component Part Numbers

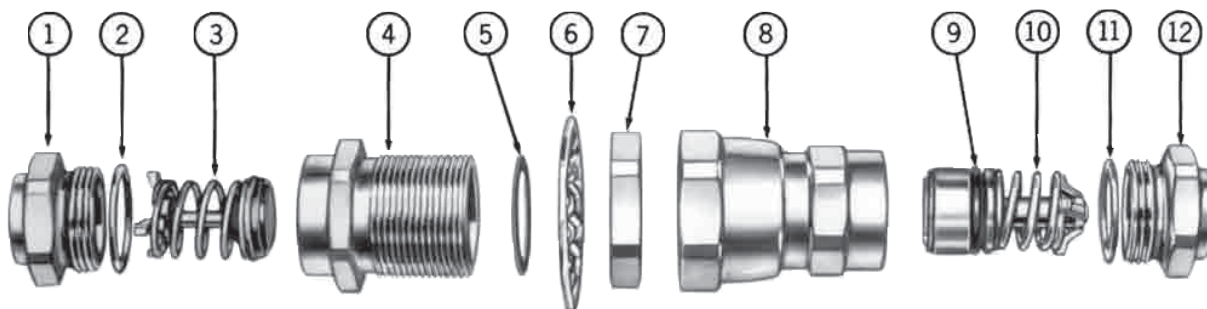

Typical Male Coupling Half (S2)

Assembly Instructions

Steps:

- After tubing or hose has been connected to adapters ① and ⑫, install O-rings ② and ⑪† on adapters. Be sure O-rings are not twisted.
- Oil O-rings ② and ⑪ liberally with system fluid to prevent them from scuffing and tearing when coupling body is threaded on adapter.
- S2 Half—Lubricate poppet face with system fluid. Insert poppet valve assembly ③ into body ④. Tighten body ④ on adapter ①. After body and adapter make metal-to-metal contact, tighten by rotating body ④ 1/8" with respect to adapter ① or torque per table value.

S5 Half—Oil O-Ring ⑨† liberally with system fluid. Insert valve and sleeve assembly 10 into body ⑧. Tighten body ⑧ on adapter ⑫. After body and adapter make metal-to-metal contact, tighten by rotating body ⑧ 1/8" with respect to adapter ⑫ or torque per table value.

- Coupling Connection—Lubricate gasket seal ⑤ on 5400-S2 half with system fluid. Thread union nut 5400-S2 half. Tighten union nut to torque values shown in table. Be sure S2 and S5 bodies do not rotate during connection.

Typical Female Coupling Half (S5)

Bulkhead Mounting—S2 Half

Install lock washer ⑥ on S2 half. Insert S2 half through bulkhead, and tighten jam nut ⑦ so that lock washer teeth are fully compressed.

NOTE: Lock washer 6 must be between hex of S2 half and bulkhead.

Maximum Bulkhead Thickness

Body Size	Lock Washer Installed	Lock Washer Not Used
1/4	.206	.256
1/2	.136	.203
3/4	.232	.292
1	.101	.161

Torque Values

Recommended torque values in ft. lbs., are listed below.

Dash Size	Adapter to Body		
	Braze Type or Aluminum	Non-braze Type Steel or Brass	S2 Half to S5 Half
-4	6-8	12-15	10-12
-8	15-20	35-45	35-37
-12	35-40	45-55	45-47
-16	50-60	55-65	65-67

IMPORTANT: Generous lubrication is required for all gaskets and O-rings. Use refrigeration oil only when used in refrigerant system.

Component Part Numbers

Item Number	Dash Size O.D. Tube Size	-4 1/4"-3/8"	-8 1/4"-5/8"	-12 5/8"-7/8"	-16 7/8"-13/8"	Line Ref.
Typical Male Half						
1	Tubing Adapter	202208-* -4	202208-* -8	202208-* -12	202208-* -16	2
2	O-ring	22546-12	22546-17	22546-23	22546-28	3
3	Poppet Valve Assembly	5400-S20-4	5400-S20-8	5400-S20-12	5400-S20-16	4
4	Body	5400-17-4	5400-17-8	5400-17-12	5400-17-16	5
5	Gasket Seal	22008-4	22008-8	22008-12	22008-16	6
6	Lock Washer	5400-54-4S	5400-54-8S	5400-54-12S	5400-54-16S	7
7	Jam Nut	5400-53-4S	5400-53-8S	5400-53-12S	5400-53-16S	8
Typical Female Half						
8	Union Nut and Body Assembly	5400-S16-4	5400-S16-8	5400-S16-12	5400-S16-16	10
9	O-ring	22546-10	22546-112	22546-116	22546-214	11
10	Valve and Sleeve Assembly	5400-S19-4	5400-S19-8	5400-S19-12	5400-S19-16	12
11	O-ring	22546-12	22546-17	22546-23	22546-28	13
12	Tubing Adapter	202208-* -4	202208-* -8	202208-* -12	202208-* -16	14

*Specify O.D. Tubing size of adapter required in 16th of an inch. Example: -4 coupling with 3/8" O.D. tubing is 6/16 or -6. Part number is then 202208-6-4.

联系方式

信德迈科技(北京)有限公司 CNMEC Technology

地址：北京朝阳区望京SOHO-T1-C座2115室

邮编：100102

电话：010 - 8428 2935 , 8428 3983

手机：13910962635

传真：010 - 8428 8762

Email：sales@cnmec.biz



信德迈
CNMEC TECHNOLOGY